

Guide to installing solid fuel stoves

Technical guidance for homeowners and trade



Guide to installing solid fuel stoves

Technical guidance for homeowners and trade

Introduction

This guide is aimed at any person who intends to install a wood burning stove in an existing building. It is assumed you will have sufficient skills to undertake the work. You are likely to be a member of a Competent Persons Scheme and authorised by your scheme operators to undertake this work. If you are not, then you will have to submit a building

regulation application to the local authority where the work is to be undertaken.

This guide is intended to assist you in the installation process, outlining key issues that may affect the safe installation of the appliance. It guides you through the regulatory requirements and stages of commissioning of an appliance.

Cross section of a typical chimney

Diagram 1 shows a cross section of a typical chimney detailing the internal parts that you will find in a chimney.

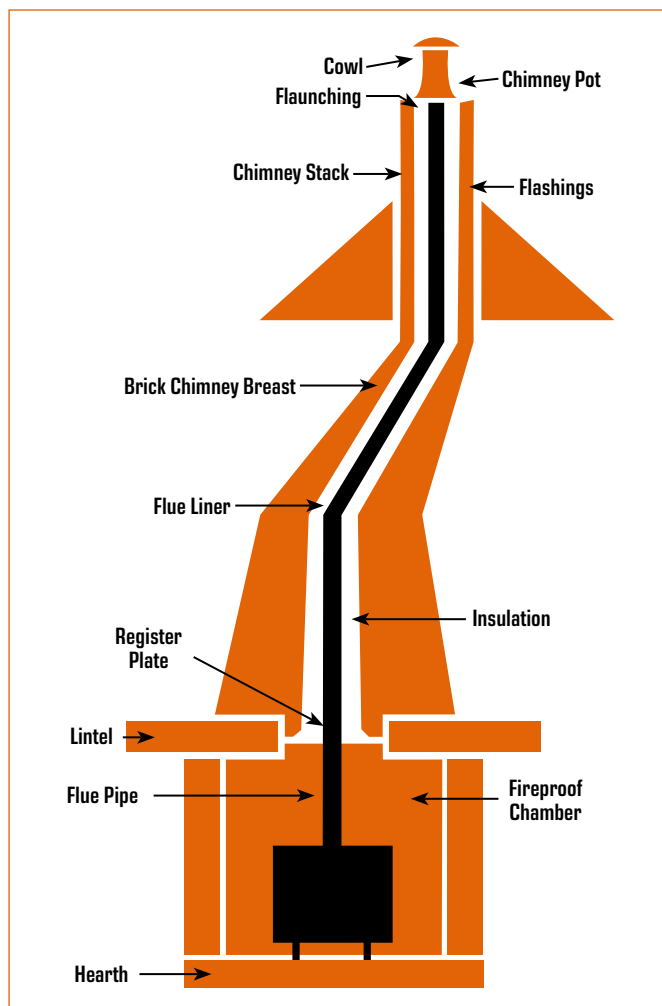

Connecting to existing chimneys

An existing chimney must be visually inspected to check that it is in good condition, clear of obstructions such as dislodged masonry or birds' nests and is of a suitable size and type for the appliance you plan to install.

Image 1: Chimney in poor condition



It is advisable to have the chimney swept before installation and it should be borne in mind old chimneys are often very inefficient and can leak potentially lethal gases through the chimney walls. It is quite common to find that old chimneys often have no lining and are in poor condition (see image 1). This is due to the flue surface and mortar joints having been corroded and eaten away by aggressive acidic condensates and soot deposits.

Prior to 1965, there was no requirement to line a chimney. However, with the introduction of national building regulations in 1965 all new chimneys had to be built with suitable flue liners of the correct size to protect the chimney structure.

If you plan to re-open a chimney after a number of years of disuse it is particularly important to have it fully checked as outlined previously. A smoke test will help establish whether there are any faults that could lead to poisonous products of combustion leaking through the chimney walls. Please read our guidance on **How to test the safety and efficiency of flues and chimneys**.

Re-lining chimneys

If an inspection identifies repair work is needed or a new liner is required to improve performance and safety, you will

need to decide on the type of flue liner that is most suited to your installation.

Factory-made relining systems are generally clay, ceramics or refractory concrete. The liner is usually lowered down the chimney on guide ropes with locating bands at the joints. This type of lining offers a long life, but the existing flue opening has to be large enough for the correct sized liners to be installed. The chimney often has to be cut open at set points to install bends in the liner. This entails a lot of remedial work and redecoration.

Steel systems are constructed from double-skinned, high-quality stainless steel, usually 904L or 316Ti (Titanium) grade. These are very different from the lightweight flexible single skin liners used for gas appliances. The flue system has a smooth internal surface and a corrugated finish externally. The flue is lowered down or pulled up the chimney and can accommodate bends in the chimney without the need for cutting out brickwork as described earlier. A slim profile enables quick installation into chimneys where other systems might not easily fit. The life of a steel system can be reduced if abnormally high corrosive soot or condensate deposits are allowed to accumulate in the flue. It is important to ensure the chimney has been properly cleaned prior to installation. Your installer may suggest backfilling the steel liner with insulation, and whilst not a requirement in Approved Document J, it should assist in improving efficiency and 'chimney draw'.

Other relining systems include the use of pumped refractory concrete, spray-on linings and ceramic coatings, but always check with HETAS or building control that such systems comply with the regulations.

Stove flue sizes

The flue size (diameter or cross sectional area) must not be smaller than the size of the stove outlet.

Building regulations state the minimum flue size for stoves is as follows:

- A smokeless fuelled stove not exceeding 20kW must have a diameter of not less than 125mm
- A stove over 20kW and up to 30kW, burning any solid fuel, must not be less than 150mm in diameter.

You are advised to install a flue of minimum size 150mm to ensure the stove is safe to use regardless of the type of fuel used.

If rectangular or square flues are used then they must have an equivalent cross sectional area with a minimum dimension of 100mm for straight flues and 125mm for flues with bends.

Single wall flue pipes

Single wall enamelled steel pipes are used to connect the stove to the chimney system. They must be positioned at least three times the diameter of the flue from combustible materials. So a 150mm pipe must be fixed at least 450mm from any combustible materials. If the combustible material is separated from the flue by a non-combustible shield, the distance is reduced to 1.5 times the diameter of the flue from combustible material. The non-combustible shield must spread beyond the flue pipe by at least 1.5 times the flue's external diameter, and have an air gap of at least 12mm between the shield and the combustible material. Cement-based fire protection boards can be used for this purpose (see diagram 2).

The single skin flue pipe connecting the stove to a chimney

Diagram 2 - Single wall flue pipes showing clearance from combustible materials

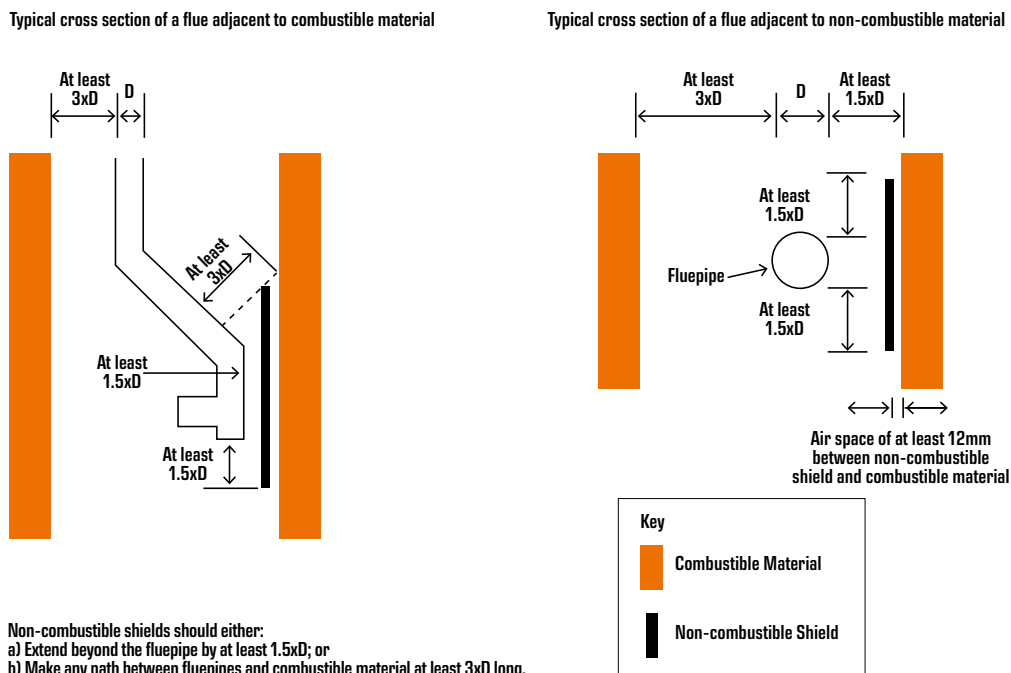

can be any length, but the flue pipe must not extend outside the room containing the stove. The length of flue pipe should be kept as short as possible to assist with chimney 'draw'.

New masonry chimneys

New masonry chimneys should be constructed with flue liners and components that are suitable for the stove that is being fitted. Steel products used for relining existing chimneys cannot be used in new chimneys.

The most common type of masonry chimneys are:

- Conventional brick or masonry construction with either clay/ceramic liners certified to BS EN 1457 or refractory concrete flue liners certified to BS EN 1857. The chimney is formed by surrounding the liners with at least 100mm of brick, block or stonework, with any gaps between the liner and surrounding structure filled with insulating concrete
- Prefabricated chimney block systems certified to BS EN 1858 with flue liners of concrete or clay/ceramic and an outer block of insulating concrete. Chimney blocks are designed to be used as a building unit and can normally accommodate a range of appliances.

All new chimneys must be built on suitable foundations with a damp proof course not less than 150mm above ground level and appropriate weathering where they pass through the roof. Further information on weathering can be found on the Lead Sheet Association's website at www.leadsheetassociation.org.uk.

It is essential to have adequate clearance from any combustible material (see diagram 3). Joists, floorboards or rafters must be spaced at least 40mm from the chimney outer face or 200mm from the inner surface of the flue. Metal fastening or support must be kept at least 50mm from the flue liner as metal is a conductor of heat.

Diagram 3 - Chimneys; Separating combustible materials from the flue liner

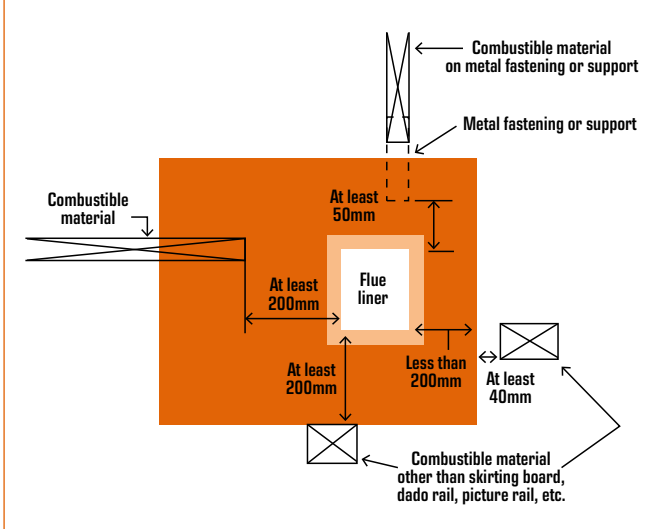
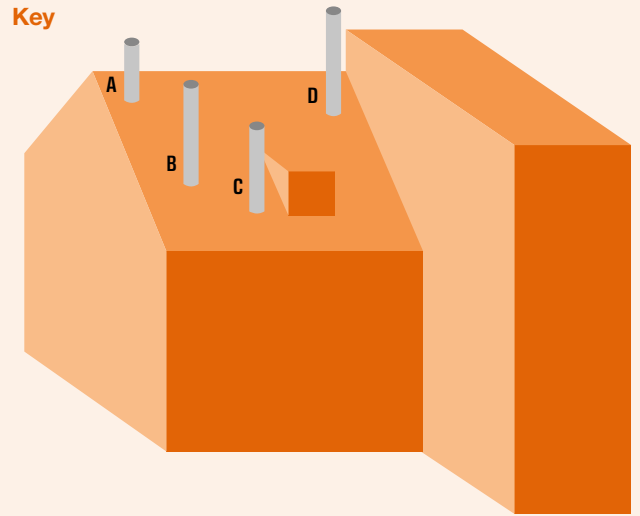

Diagram 4 - Typical flue outlet positions for a traditional roof as shown in Approved Document J



Point where flue passes through weather surface (Notes 1, 2)	Clearances to flue outlet	
A	At or within 600mm of the ridge	At least 600mm above the ridge
B	Elsewhere on a roof (whether pitched or flat)	At least 2300mm horizontally from the nearest point on the weather surface and: a) at least 1000mm above the highest point of intersection of the chimney and the weather surface; or b) at least as high as the ridge
C	Below (on a pitched roof) or within 2300mm horizontally to an openable rooflight, dormer window or other opening (Note 3)	At least 1000mm above the top of the opening
D	Within 2300mm of an adjoining or adjacent building, whether or not beyond the boundary (Note 3)	At least 600mm above the adjacent building

- Notes**
- 1) The weather surface is the building external surface, such as its roof, tiles or external walls.
 - 2) A flat roof has a pitch less than 10°.
 - 3) The clearances given for A or B, as appropriate, will also apply.

Factory-made metal chimneys

These systems are used as an alternative to masonry chimneys and consist of interlocking sections with a stainless steel outer casing. The casing encloses high performance insulation and a flue liner of either stainless steel, ceramic or refractory concrete. Metal systems are likely to give an operating life of at least ten to 15 years when correctly installed, operated and maintained. Prolonged periods of slow burning, combined with inadequate cleaning of the flue, can cause corrosion damage, which may reduce the expected life of the liner.

They should have the BS EN 1856 part 1 mark and show the minimum safe distance (in millimetres) for clearance from the chimney outer wall to any combustible material. Access inspection hatches of at least 300mm² must be provided to enable commissioning and maintenance checks.

If the metal chimney passes through a cupboard, room or roof space it must be guarded to prevent any combustible material being closer than the minimum separation distance mentioned above. Where passing through a floor, manufacturers' fire stop components must be used to separate the chimney from any timber to maintain the fire resistance of the floor.

Outlets from flues and chimneys

Flue gases from the stove must be able to discharge freely without presenting a fire or health hazard, whatever the wind conditions. To ensure the chimney operates properly the flue outlet needs to be positioned sufficiently high above the roof surface and surrounding buildings to prevent it being affected by wind eddies or down drafts (see diagram 4). Approved Document J provides further guidance on how this is achieved.

- The flue outlet position is measured to the top of the chimney pot/terminal or 150mm above the top of the masonry stack enclosing the liner - whichever is the lower
- For roofs covered with combustible materials like thatch or shingles, Approved Document J provides guidance on greater clearances that may be necessary
- Any of the above dimensions may need to be increased where there is exposure to high wind speeds, adjacent tall buildings, high trees or high ground.

Hearths for stoves

A hearth provides a slab of non-combustible material that isolates the stove from any combustible materials underneath and around it. This prevents any heat from the stove or burning

fuel that might accidentally fall out of it igniting adjacent combustible material. The perimeter of the hearth should be clearly defined by either using a raised edge or by raising the level of the hearth in relation to the floor.

The hearth must project a minimum of 150mm from the stove sides and 300mm from the stove front when in a fireplace recess. This can be reduced to 225mm if the stove is designed to operate with its door closed. But if the stove is designed to operate with the door open it is recommended the 300mm dimension is adopted. The minimum hearth size for a freestanding stove (not in a recess) is 840 x 840mm (see diagram 5).

Hearth's thickness

If the hearth is situated over any combustible material it must be at least 125mm thick and have an air gap of 50mm between its underside and the combustible material. If an air gap is not possible there should be no combustible material within 250mm of the top surface of the hearth (see diagram 6).

Diagram 6 - Hearth thickness

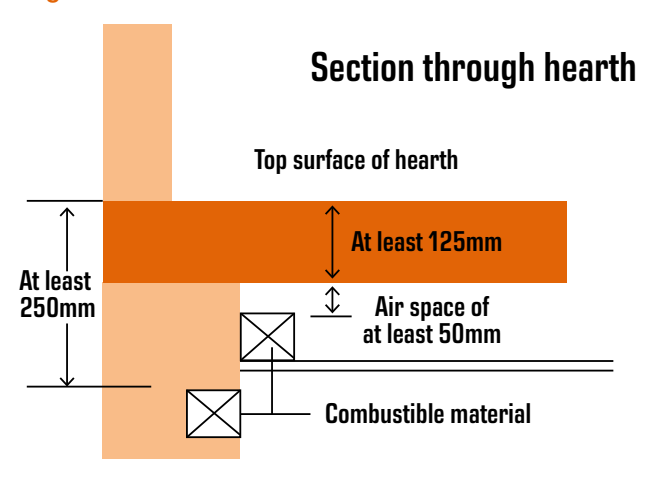
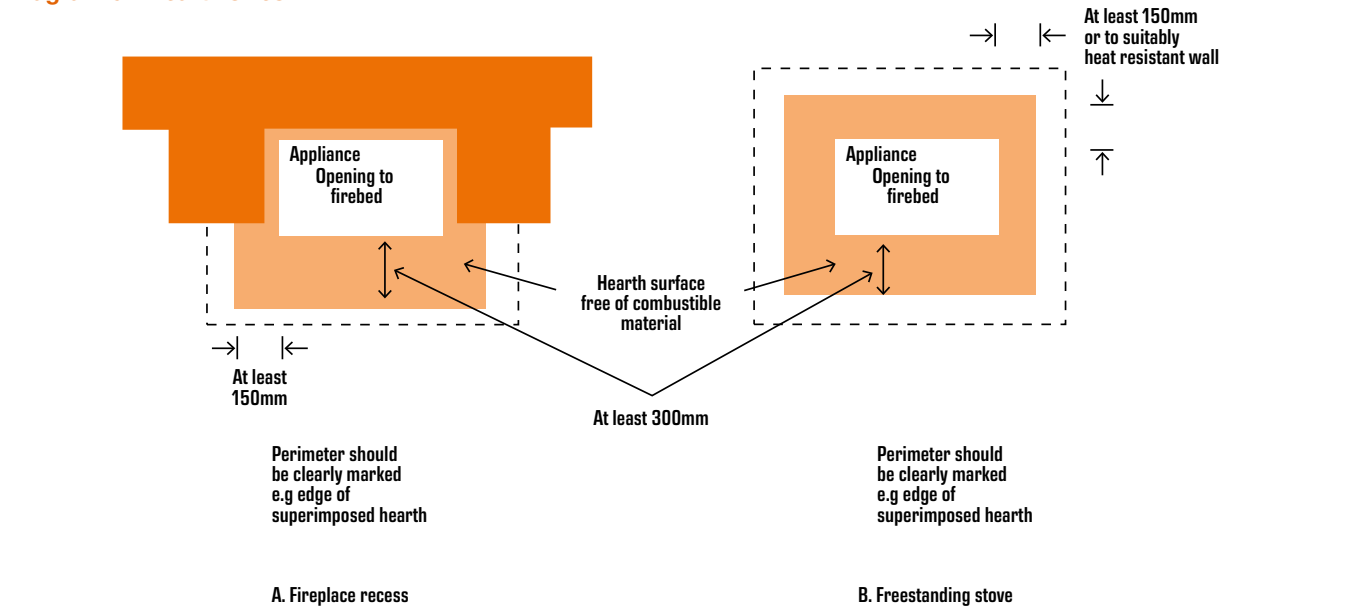

Diagram 5 - Hearth sizes



If the hearth is on a solid concrete floor slab or pre-cast concrete beam and block type floor then the total thickness of the hearth and floor must be at least 125mm. Combustible insulation should not be placed under it unless there is at least 250mm clearance as above.

If a stove is not sited in an appliance recess and has been tested and shown not to raise the hearth temperature to over 100 degrees centigrade, then a 12mm non-combustible hearth may be used.

Ventilation for stoves

It is essential to ensure you have a permanent source of air to enable proper combustion to take place. A poor supply makes stoves harder to light and can cause them to discharge smoke into the room.

In extreme circumstances, where ventilation is inadequate, gases will not fully burn. This can result in the production of carbon monoxide, a highly toxic colourless and odourless gas that has potentially fatal consequences. (See CO alarms page 7)

In recognition of this, Approved Document J lays down stringent standards for providing a permanent supply of combustion air to the room containing the stove.

Recent changes to building regulations on energy efficiency have resulted in buildings becoming more airtight to prevent uncontrolled loss of heat. These buildings must be provided with additional designed ventilation to ensure appliances operate properly (see table 1).

Table 1: Permanent ventilation areas

Stove with a draught stabiliser fitted	Building air tightness > 5.0m ³ /hr.m ² 300mm ² for each kW up to 5kW 850mm ² for each kW thereafter.
	Building air tightness ≤ 5.0m ³ /hr.m ² 850mm ² for each kW
Stove with no draught stabiliser fitted	Building air tightness > 5.0m ³ /hr.m ² 550mm ² for each kW above 5kW
	Building air tightness ≤ 5.0m ³ /hr.m ² 550mm ² for each kW

A house built before 2006 is unlikely to have an air tightness of less than 5.0m³/h.m², whereas a house built after this date is likely to meet this standard. Some stoves can draw outside air directly into the appliance through a duct. Where this is not the case a vent should be placed so that it cannot be easily blocked to reduce draughts or noise.

Ventilation areas in table 1 are 'free area' and not simply the cross sectional area of the air brick or louvered cowl. Most products are stamped with the free area they provide. As

Diagram 7: Location of permanent vents

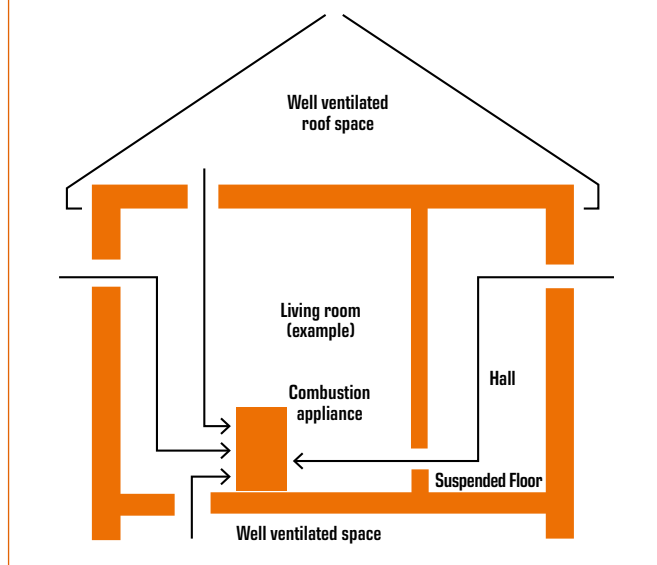
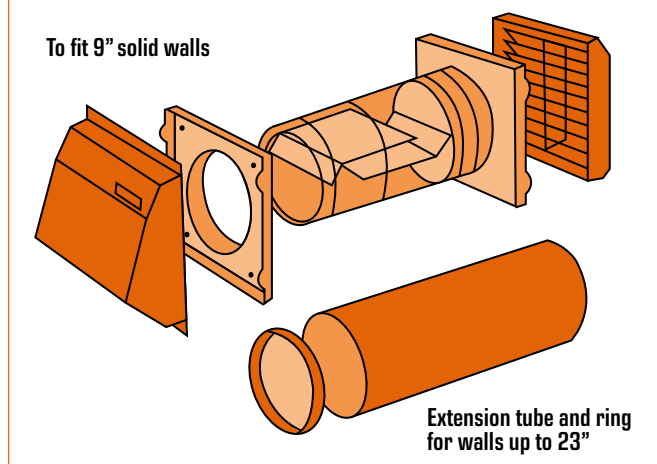

Diagram 8: Vent showing baffles



as a guide, a single 215mm x 65mm plastic air brick provides approximately 6,000mm², whilst a similar sized clay air brick will only give 1,300mm². If a mesh is installed to guard against pests/mice etc entering the house the mesh size must be no less than 5mm.

The vent can be fixed in the walls, ceiling or floor and does not have to be in the same room as the stove (see diagram 7). Ventilation can be provided from another room which itself has permanent ventilation to the outside. A well ventilated roof space or under floor void can also provide a convenient source from which to draw a supply of combustion air. Where the vent is in the same room as the appliance, it is preferable to position it close to the stove to reduce draughts and retain room heat.

Some vents are available (see diagram 8) that can be installed using a 125mm core drill. They incorporate a series of baffles inside the duct to reduce wind noise.

Notice plates

Notice plates must be provided for a new or replacement

hearth, flue or chimney, flue extension or flue re-lining. The notice plate must provide information on the correct operation and use of these facilities. The plate must be permanently fixed in the building in a location adjacent to:

- the electricity consumer meter
- the water stop-cock
- the hearth or flue that it describes

The notice plate must show the location of the hearth and/or flue and give essential information about the materials used, which includes the manufacturer and flue diameter (see diagram 9).

Diagram 9 – Example notice plate for hearths and flues

Essential information	IMPORTANT SAFETY INFORMATION	
	This label must not be removed or covered	
	Property address.....	20 Main Street New Town
	The hearth and chimney installed in the.....	lounge
	are suitable for.....	decorative fuel effect gas fire
	Chimney liner.....	double skin stainless steel flexible, 200mm diameter
	Suitable for condensing appliance.....	no
	Installed on.....	date
Optional additional information	Other information (optional).....	
	Designation of stainless steel liner stated by manufacturer to be T450 N2 S D 3	
e.g. installer's name, product trade names, installation and maintenance advice, European chimney product designations, warnings on performance limitations of insulation elements e.g. false hearths		

Carbon monoxide alarms

The building regulations require the installation of a carbon monoxide alarm complying with BS EN 50291:2001 in rooms containing solid fuel combustion appliances. These devices are usually battery powered and have an alarm to alert users when the working life of the detector is due to expire.

Alarms should be within one to three metres of the appliance and either;

- On the ceiling at least 300mm from any wall or;
- On a wall as high up as possible (above doors and windows) but at least 150 mm from the ceiling

The provision of an alarm is not a substitute for regular servicing of the stove and flue.

Commissioning checklist

It is the policy of many local authorities to require installers to provide them with a commissioning checklist following the installation of a solid fuel stove and/or a new chimney or chimney lining.

Planning permission

Fitting, altering or replacing an external flue or chimney does not normally require planning consent providing the flue is on the rear or side elevation of the building, subject to being a

maximum of 1 metre above the highest part of the roof.

If the building is listed or in a designated area it is advisable to check with your local planning authority before a flue is fitted. In a designated area the flue should not be fitted on the principal or side elevation that fronts a highway.

The above information is restricted to houses only. For advice on flats or maisonettes contact the development control department at your local council.

Smoke control zones

The Clean Air Act designates some areas as smoke control areas. This affects the type of appliance you can install and the fuel that can be burned in it. For further information contact the environmental health department at your local authority.

Key points

10 key points to consider:

1	Check an existing chimney for condition and obstructions
2	Ensure prefabricated or manufactured components comply with the relevant British Standards
3	Where possible, adopt a minimum internal flue size of 150mm diameter
4	Is the flue outlet positioned sufficiently high above the roof surface?
5	Make sure you isolate the flue from any combustible material
6	Ensure the stove is positioned on a proper non-combustible hearth
7	Check you have a sufficient air supply for combustion
8	Provide carbon monoxide alarms
9	Provide proper permanent notices about the appliance in the building
10	Ensure you have all formal permissions before starting work

Other information

The following websites may be useful in obtaining further information about the installation of solid fuel stoves:

- www.hetas.co.uk
- www.feta.co.uk/bfcma
- www.nace.me.uk
- www.labc.co.uk for building regulations and planning advice

This guide has been produced with support from our Hertfordshire Technical Forum Group.

Further technical guides

How to test the safety and efficiency of flues and chimneys

Front page image courtesy of Jetmaster (www.jetmaster.co.uk)

LABC is a membership organisation representing all local authority building control teams in England and Wales who work with industry and building professionals to ensure compliance with Building Regulations. We are a not-for-profit organisation dedicated to promoting public sector expertise.

There are 3,000 surveyors working in local authority building control providing a consistent national service that is delivered at a local level. To find your local authority building control team please use our postcode search by visiting our website: www.labc.co.uk

Contact us:
LABC
Third Floor
66 South Lambeth Road
London
SW8 1RL

T. 020 7091 6860
E. info@labc.co.uk
W. www.labc.co.uk
Follow us on twitter @labcut